

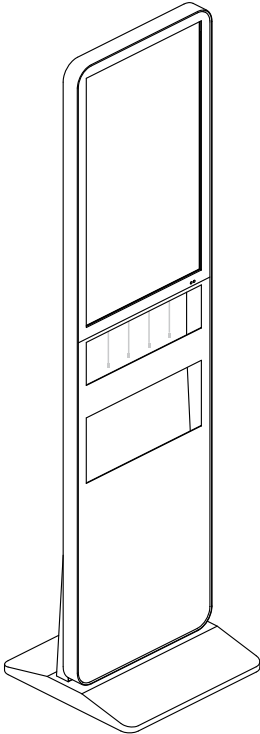

User Manual



Model: DG32FLR7

Description:

32 inch Digital Charging Literature Holder

FCC ID: 2ASCB-DG32FLR7

This device complies with Part 15 of the FCC Rules. Operation is subject to the following two conditions:

- (1) this device may not cause harmful interference, and
- (2) this device must accept any interference received, including interference that may cause undesired operation.

Any changes/modifications to this equipment not approved by George Patton Associates could void the user's authority to operate the equipment.

Scan QR code to visit the product page:



Operating Instructions for Digital Signage

Note: Before using the product, please read the instructions carefully!

Do not attempt to disassemble this product. If the product does not work properly, please call our Customer Service Department at 1-844-221-3393.

Contents

Features	4
Safety Warnings and Precautions	4
Assembly	6
Parts List	7
Product Composition.....	8
Assembly	9
Remote Control for LCD Operation	9
Installing batteries for the remote control	9
Precautions for using the remote control	9
Description of remote control buttons	9
Description of Basic Operation	10
Power on/Standby	10
Interface and Home Screen.....	10
Description of Wallpaper Switch.....	11
File Manager	11
Local Settings	12
Description of Settings Interface	12
Status of Menu bar	13
DiViEx APP Introduction	13
System requirements	13
How to upload media files	13
Settings	15
Edit picture	15
Music	17
Factory Reset.....	17
Screen Rotation	18
Choose System Language.....	19
Technical Specifications	20
Troubleshooting the Digital Signs	23
Cleaning and Maintenance	25





Features

1. Embedded with Android 7.1 smart operating system and unique UI design, bringing you a more convenient operation and better visual experience.
2. Support USB mouse and keyboard, realizing easy manipulation like a computer. Using a mouse for set up is recommended.
3. Built-in Wi-Fi module, high capacity memory and high capacity cache, making it smoother to watch 1080P HD movies and play big games.
4. High-quality LCD screen as the display, no flicker, low radiation, greatly reducing eye fatigue, eye protection, high brightness, high contrast, and wide viewing angle; ultra-fast response time greatly reduces ghosting of fast moving images.
5. Progressive image processing and industry-leading motion compensation technology improve the flickering and blurring in the edges of motion picture.
6. Dynamic contrast technology can significantly improve the clarity and contrast of various screens.
7. Multi-channel USB interfaces, supporting HD media streaming.
8. Ultra-thin narrow bezel design.

Safety Warnings and Precautions

Thank you for purchasing the high-performance multi-functional LED backlight Digital Signage from Displays2go. We have considered the factors to ensure personal safety in product design and have tested rigorously at the factory. However, improper installation and use may result in electric shock and fire. In order to safely use, maximize performance of the unit and extend the life of the product, please read and follow all instructions carefully before using the product. Keep the instructions for future reference.

Symbol Legends:

-  **Warning: May cause personal injury or death**
-  **The operation is prohibited**
-  **Caution: May cause damage or property loss**
-  **The operation must be executed**

If any of the following occurs:

- Power outage or instable voltage.
- Abnormal sound or smell from the unit.
- AC power cord is damaged.
- Digital Interactive Table is damaged due to drop, knock or impact.
- Any liquid or foreign matters fall into the enclosure.



Turn off the Digital Interactive Table immediately, pull out the plug from the power outlet, and ask the authorized personnel for maintenance timely.

 **If coal gas or other flammable gas leaks, do not pull out the plug of the LCD Digital Signage or other electrical appliances; instead, turn off the gas valve immediately, and open the doors and windows quickly.**

 **WARNING**

- Do not use power supply other than AC 110V, 50Hz.
- Cut off the power supply before connecting or disconnecting any cables.
- Do not place the Digital Signage on any instable positions, or else it may be damaged or cause fire.
- Do not place the Digital Signage in the positions such as:
 - 1.The environment subject to direct strong sunlight, moisture, extreme temperature or too much dust;
 - 2.The environment with flammable or explosive materials;
 - 3.The environment with flammable or corrosive gases;
- Do not use damaged or inappropriate power outlets, and ensure that the plugs and outlets contact properly.
- Do not let dust or metal deposits adhere to the plugs and outlets.
- Do not damage the power cords:
 - 1.Do not modify the power cords;
 - 2.Do not place heavy objects on the power cords;
 - 3.Keep the power cords away from heat source;
 - 4.Do not pull the cord to remove the plug.
- Do not connect too many plugs to one outlet in parallel, or else it may cause fire due to excessive power consumption.
- Do not approach the Digital Signage with open flame (e.g. a lighted candle), or else it may cause electric shock or fire.
- Do not put water filled container on the Digital Signage to avoid electric shock and fire due to water drops or splashing.
- Do not put any sharp objects, metal or liquid into the vents or let them touch the signal terminals to avoid short circuit, product damage, and electric shock.
- The openings in the enclosure are designed for ventilation and cooling, to ensure long time reliable running of components inside the enclosure and prevent overheating. Do not block the openings when place the unit.

 Do not touch the plugs with wet fingers, or else it will cause electric shock.

— Do not use the Digital Signage in stormy weather, especially when there is lightning; instead, please disconnect the power and antenna plugs to avoid lightning strike.

 Do not disassemble the Digital Signage without permission, or else it may cause electric shock or fire. Please ask qualified technician for repair.











- Do not let children climb onto the Digital Signage.
- Keep the small parts away from children to prevent them from swallowing.
- If the Digital Signage won't be used for a long time, please turn it off and pull out the power plug.
- To adjust the position or angle of the Digital Signage, please disconnect all power cords and move slowly to avoid falling.
- Do not scratch or knock the LCD with hard object, or twist and squeeze the LCD.
- Do not turn on the unit immediately when it is moved from a place with low temperature to high temperature, or else it will cause condensation and malfunction.
- Before cleaning the Digital Signage, please pull out the power plug; wipe with soft cloth; do not use industrial chemicals; prevent foreign matters from entering the machine. Improper cleaning (such as cleaning solution, water) may damage the product, erase the printed information, and even cause damage of the components if fluid flows in, resulting in machine failure.
- If the unit displays the same screen for a long time or the moving picture has fixed text or icon, it will leave ghosting on the screen and won't disappear when the unit is turned off; it is normal and isn't covered by the warranty.
- The power of the Digital Signage can be cut off by pulling out the plug.
- If the LCD screen ruptures and the liquid splashes on the skin, please rinse for 15 minutes with clean water immediately, and consult your doctor.
- To carry the Digital Signage with hands, please grab the corners and hold the bottom; do not apply pressure on the panel.
- Use the Digital Signage properly: Use in proper lighting conditions; insufficient lighting or long time watching will impair your eyesight.
- When the plug or coupler is used as disconnection device, it should be easy to operate the device.
- Insert the plug into the outlet properly, or else it may cause sparks and fire.
- The technical specifications printed herein and on the packaging are subject to change without prior notice. The Manual may be slightly different from actual operation, and the latter is applicable.

Assembly

Note:

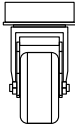
Contact D2G if you have questions about the operation, debugging and connection of the unit; if the unit doesn't work normally, please cut off the power immediately and consult the dealer. The unit is class-A product, which may cause radio interference in living environment. In this case, please take feasible measures, and use power plug as the disconnection device.

Parts List

Accessory	Picture	Qty
AC Power cord		1
LCD Remote Control		1
Key		2
M8x20 screws		12
M8x16 screws		16
Caster		4
Washer		12
Wrench		1
User menu		1

Product Composition

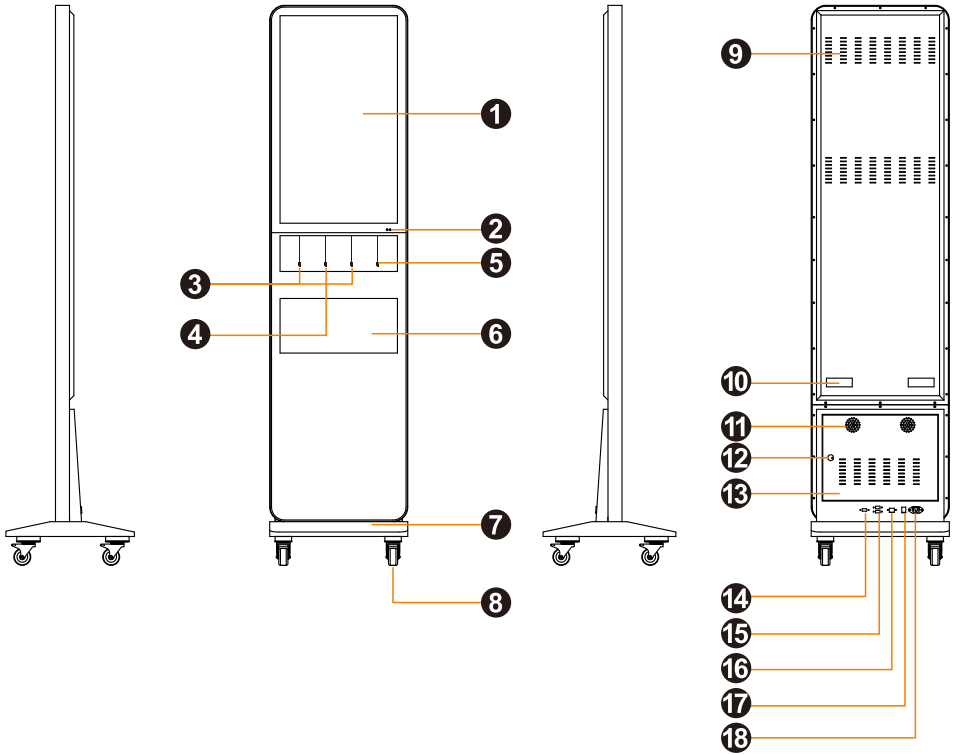

1 LCD screen

2 IR indicator

3 Iphone lightning

4 Micro USB Cable

5 Type-C

6 Brochure holder

7 Base

8 Caster

9 Heat sink holes

10 Handle

11 Speaker

12 Lock

13 Door

14 HDMI port 

15 USB port 

16 Ethernet port (RJ45 socket) 

17 Power switch 

18 AC power socket 

* Assembly

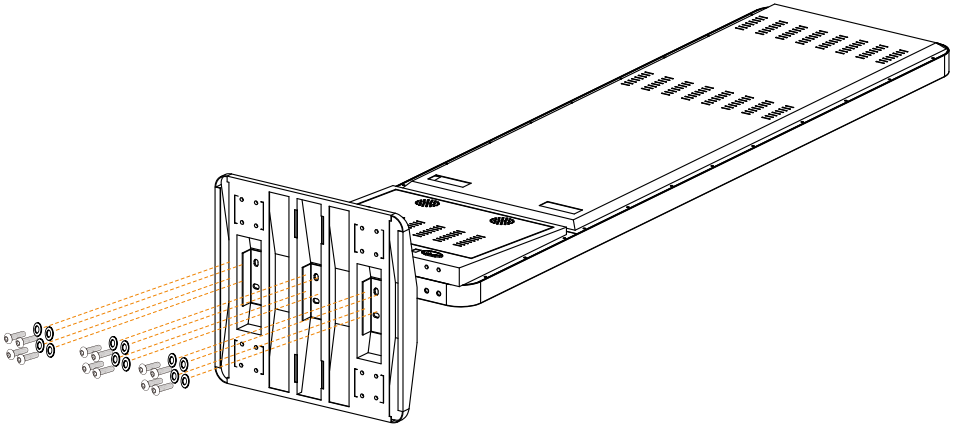

1. Lay the LCD screen and the base on a soft and non-abrasive surface, and fix the LCD screen and the base using M8x20 screws provided.

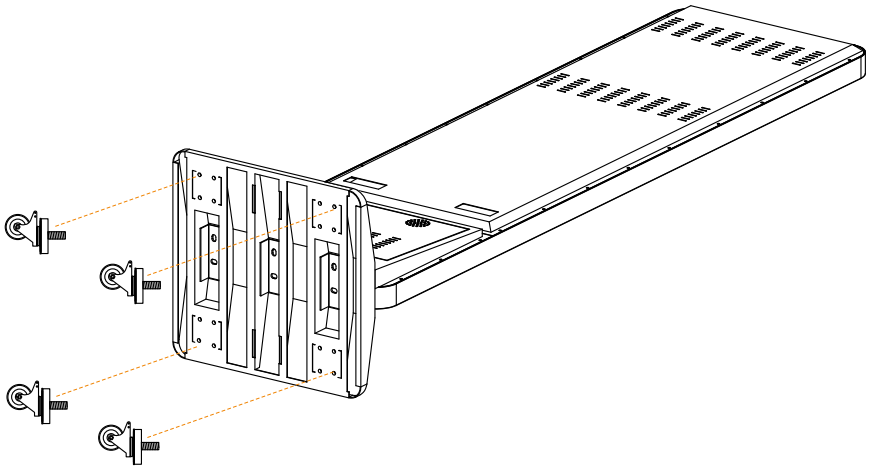

2. Fix the 4 casters with the base using M8x16 phillips screws provided.

Remote Control

















Installing batteries for the remote control:

Remove the battery cover and insert two AAA batteries (1.5V). Ensure that the battery polarity matches the “+”/“-” marks in the battery compartment of the remote control.

Precautions for using the remote control:

- Aim the remote control at the receiver window. Do not place any object between the remote control and the receiver window to avoid interference with the normal operation.
- Keep the remote control away from violent vibration. In addition, do not set or place the remote control in direct sunlight, or else the remote control may be deformed by heat.
- The remote control may be invalid when the receiver window of the unit is in direct sunlight or strong lighting; in this case, please adjust the angle of the lighting or the unit or approach the receiver window to use it.
- The distance of remote control will be shortened if the battery voltage is insufficient; in this case, please replace with new batteries; if the remote control won't be used for a long time or the batteries are run out, please take out the batteries to avoid corrosion due to battery leakage, which will damage the remote control.
- Do not use batteries of different types or mix new batteries with old ones. Always replace the batteries in pairs.
- Do not put the batteries in fire, or charge or disassemble them, or charge, short circuit, disassemble, heat or burn used batteries. Please dispose of waste batteries in accordance with local environmental regulations. Do not expose the batteries in overheated environments such as sunlight and fire.

Remote control buttons:

	Power switch		Play programs; confirm selection
	To show the Source menu		Display indication
	Mute		Home page
	Turn down the volume		Back
	Turn up the volume		To show the main menu
	To move the cursor up		To set up OSD menu
	To move the cursor left		Input numbers
	To move the cursor right		
	To move the cursor down		



NOTE: Press the SETUP button in the main interface to call out the OSD menu. After exiting the playback mode by pressing the STOP button, the playback will start according to the schedule next time.







Description of Basic Operation

Power on/Standby

Insert the power plug into the outlet. Turn the power switch to “ON” at the back of the Digital Signage. When powered on, enter “System Assistant” and press the “⏻” button on the remote control, and the Digital Signage enters standby state.

About Launch Desktop

Description of Desktop Icons

Icon	Function
	App Drawer
	Back
	Home page
	Background applications
	Sound -
	Sound +



Description of Wallpaper Switch

We suggest using a mouse to change the wallpaper.

Connect a mouse with the digital panel through USB port, then follow the steps below:

1. click "Setting"
2. At the setting menu, click "Display"
3. At the Display setting menu, click "Gallery", or "Wallpaper"
4. Then select an image you would like to set up as background.
5. Confirm the selection by clicking "Set wallpaper".

File Manager

1. Click the Main Apps button "⋮" in the Home page to enter the "APPS" menu interface (Fig. 2);
2. Click the "Explorer" icon in the "APPS" menu interface (Fig. 2) and enter "Explorer" menu (Fig. 3);
3. Click options in the "Explorer" menu to read the files from different devices.

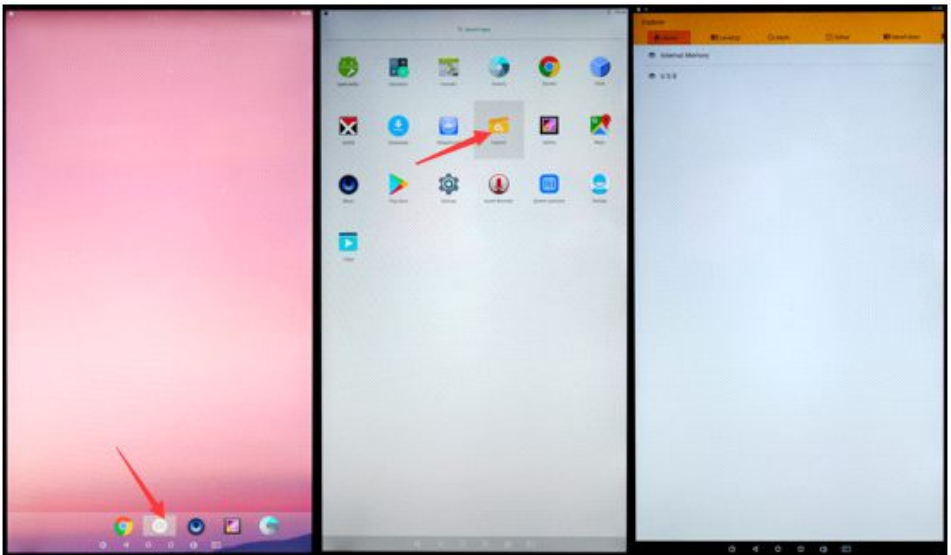



Fig. 1

Fig. 2

Fig. 3

Local Settings

1. Click the Main Apps button “

 A screenshot of an Android home screen with a grid of app icons. A red arrow points to the 'Main Apps' icon, which is a blue square with a white gear-like symbol.

Fig. 1

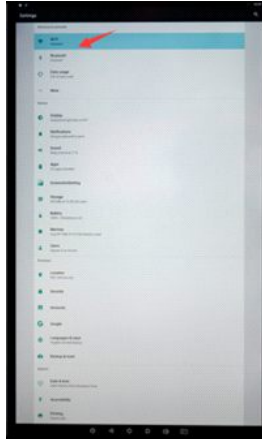





Fig. 2



Fig. 3

Description of Settings Interface (shown on the right)

Icon	Function
	WiFi switch
	Bluetooth
	Data usage
	Display
	Notifications
	Sound
	Apps
	Screenshot Setting
	Storage
	Battery
	Memory
	Users
	Location
	Security
	Accounts
	Google
	Languages & input
	Backup & reset
	Date & time

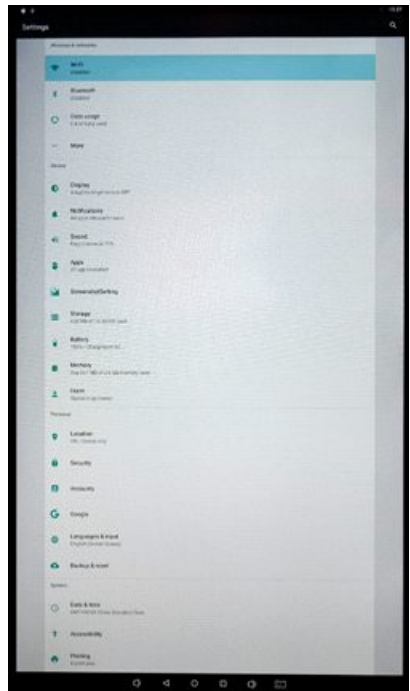

Status of Menu Bar

1. Click the setting (Fig.1)
2. At the setting menu click Display (Fig.2)
3. At the display setting menu unselect the display navigation check box. (Fig.3)

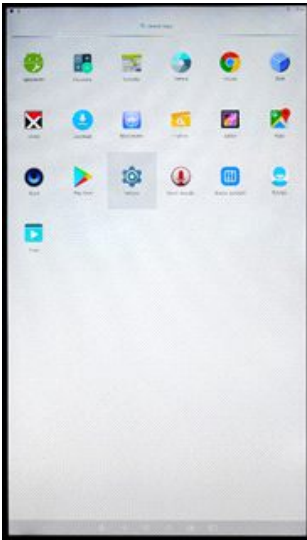

Fig. 1



Fig. 2



Fig. 3

DiViEx APP Introduction

System requirements:

Step 1: Before using the APP, make sure your device meets or exceeds the following system requirements:

CPU	Rk3288
ROM	16GB
Operating system	Android 7.1

How to upload media files:

Step 2: Plug in your USB drive to the computer. Open the drive in Windows Explorer and create a new folder, rename it "MediaFolder". As shown below:



Open "MediaFolder", create 3 subfolders, and change their names to "Images", "Videos", "Music". Copy the media file to be displayed, image to "Images", video to "Videos", Music to "Music"



Supported Media Format:

Image	JPG/JPEG/BMP/PNG
Video	AVI, MPEG4, WMV, MKV, FLV, MP4, MOV
Music	AAC/MP3/AMR/OGG

Step 3: Plug the USB drive into the device and click the DiViEx APP.

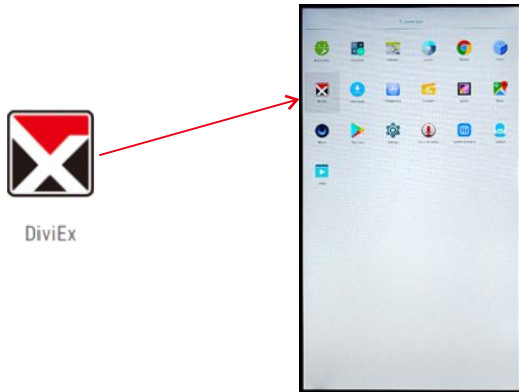

Step 4: When the screen shows "Copy finished" after "Usb Disk:", the media files are ready to be displayed.

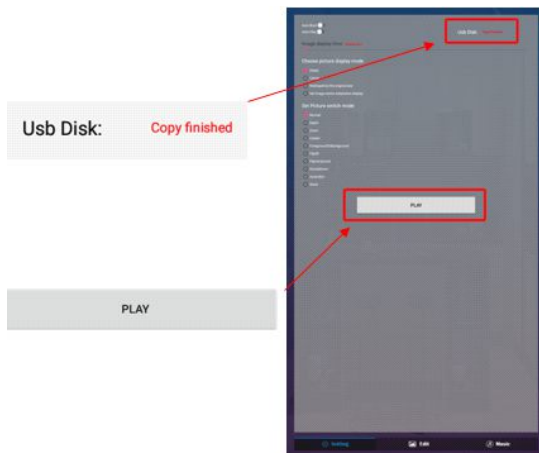

Settings:

1. Set the time each picture is to be shown on the screen by dragging the bar to the desired time.
2. Select how you would like the images to display. Select the desired transition effect between pictures:
 - **Auto Boot**
DiViEX APP will automatic open when the digital signage is turned on.
 - **Auto Play**
DiViEX APP will automatic play the slideshow when it is opened.
 - **Choose Picture display mode**
Check a fit option how you want the pictures to be displayed.
 - **Set Picture switch mode**
Choose an animation option to set the fade in and fade out effects.



Edit picture:

This function shows all pictures, you can edit all pictures, and remove it.

- **Crop**
There are four corner handles and four border handles to crop the picture. Click and drag a handle to reshape the image to any size you need.
- **Filter**
You can browse and try different filters in the filter gallery below the image. The APP support the following filter: AUTO_FIX, BLACK_WHITE, BRIGHTNESS, CONTRAST, CROSS_PROCESS, DOCUMENTARY, DUE_TONE, FILL_LIGHT, FISH_EYE, FLIP_HORIZONTAL, FILP_VERTICAL, GRAIN, GRAY_SCALE, LOMISH, NEGATIVE, PSTERIZE, ROTATE, SATURATE, SEPIA, SHARPEN, TEMPERATURE, TINT, VIGNETTE.
- **Reset**
Click "Reset" to remove all the editing you applied to the image.
- **Save** 
Click the icon to save the edited image as a new image.



- **Image deletion**

Click "✕" to delete unwanted pictures

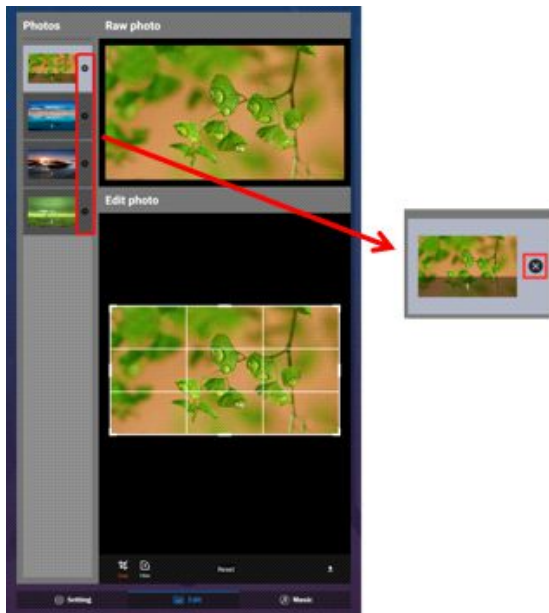

Music:

List all music files in the Playlist library

- Add music to “Playing List Music” (Background music) from “Playlist Library”. Click “right arrow”, music title will show in the “Playlist Music” on the right.

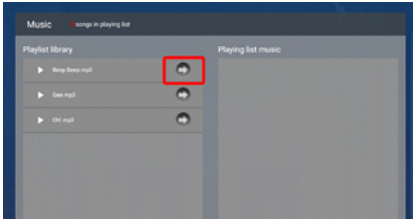

- To remove the added music file from the playlist, click the “left arrow” in the playlist.

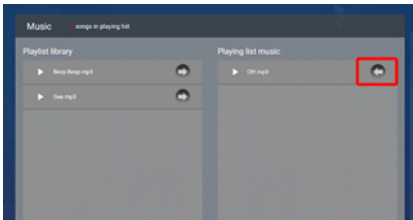

Factory Reset:

1. Go to Settings, then click “Backup & reset” (Fig. 1)
2. Click “Factory data reset” (Fig. 2)
3. Choose “Reset Tablet”, then click “ERASE EVERYTHING” to get the unit to default settings. (Fig. 3)

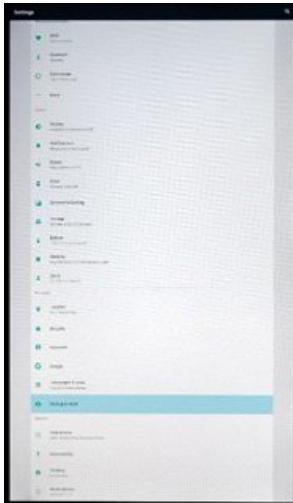

Fig. 1



Fig. 2



Fig. 3

Screen Rotation



1. Click the Main Apps button “A vertical smartphone screen with a pink-to-purple gradient background. At the bottom, there is a dock with five icons: a globe, a house, a power button, a document, and a person. The Main Apps button, represented by a grid of dots, is located in the bottom right corner of the dock.

Fig. 1

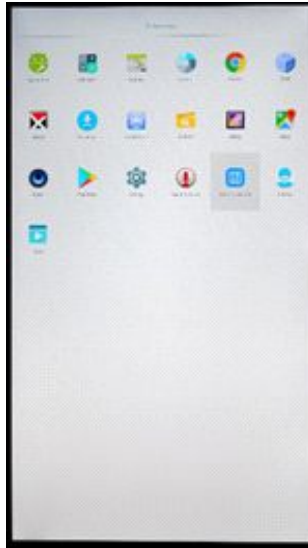

Fig. 2



Fig. 3

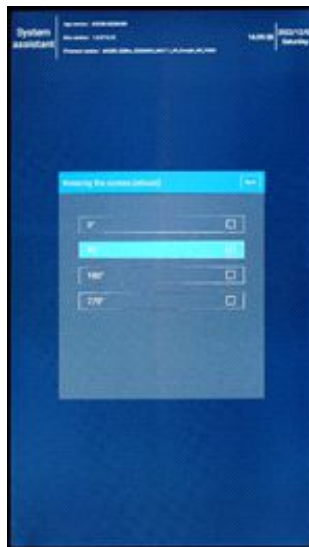

Fig. 4

Choose System Language:

1. Get into Settings, then click “Language & input” (Fig. 1)
2. Click “Languages”, then click “Add a language” (Fig. 2)
3. You can add the required system language (Fig. 3)
4. Drag the system language you just added up to the front (Fig. 4)-Please use a mouse to operate.

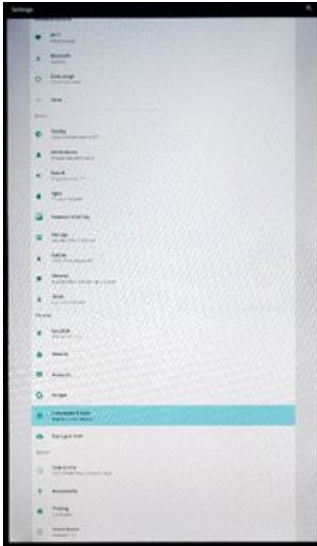

Fig. 1



Fig. 2



Fig. 3

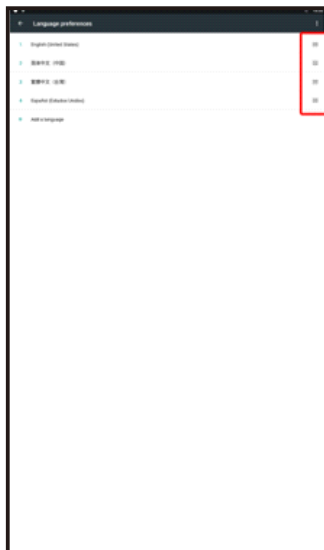

Fig. 4

Technical Specifications



	ITEM	SPECIFICATION
Product / LCD	Material	Alu.+Steel
	Panel Type	32" BOE LCD
	Display Area	698.4*392.85mm
	Optimum Resolution	1080*1920
	Contrast Ratio	1200:1
	Viewing Angles	89/89
	Response Time	8ms
	Light Source	LED
	Brightness	400nits
	Pixel Pitch	121.25(H)X363.75(V)
	Display Colors	16.7M(8bits-true)
	Color Temp	Cold white
	Aspect Ratio	9:16
	Refresh Rate	50/60HZ
	Panel Surface Material	TFT
	Touch	NO
	Operating Time	7x18hrs
	Panel Life (hours)	30000hrs
CMS	Operating System	Android 7.1
	Software	DiViEX
	Player	Integrated in software
	Drive Type	Integrated in software
	External or Integrated	Integrated
	Templates	yes
	Maximum video decoding	1080P
	HTML5	No

CMS	IP Streaming IP	yes, but subject to bandwitch
	Live Text & Media Feeds	USB; SD; WIFI; Wire Network
	Multi-Zone	YES
	Transitions	YES
	Day Parting	YES
	Scheduling	YES
	Drag & Drop Functionality	YES
	Loops	YES
	Campaigns	YES
	Remote Content Update	YES
Video	Video playback	YES
Audio	Audio format	MP3
Image	Picture format	JPG, JPEG, BMP, PNG, GIF
Input	Video Input	NO
	Control Input/Output	Output
Storage	Internal Storage Capacity	16GB
Speaker	Amplifier	YES
Connector	Control	Rockchip RK3288W, Quad-core ARM Cortex A17 CPU (Up to 1.6GHz)
	SD Slot	NO
	Ethernet LAN	YES
	Audio_IN	NO
	USB	YES
	HDMI	YES
	VGA	NO
	Digital	NO
	USB/SD/Micro SC/HDMI: list all	USB/HDMI/RJ45
	Power	YES

Charging Spec	Cables included	2x Lightning, 1x Micro-USB, 1x Type-C
	Input Voltage	DC12V
	Input Current	2.3A
	Output Voltage	5V
	Output Current	Max. 2.4A/port
	Short Circuit Protection	Yes
	Over load Protection	Yes
	Over Voltage Protection	Yes
	Over Temperature Protection	Yes
Power	Voltage (in/out)	AC100-240V
	Consumption (Watts)	About 64W
	Cord Length	1.5m
	Compliance Listed (on power source)	Power supply with UL listed
Operating Conditions	Temperature	Operating temperature: 0-40°C Storage temperature: -20-60°C
	Humidity	10-80%
Product Dimensions	Screen	32"
	Overall Unit	468mm(W)*1800mm(H)
Weight	Net	33.7kgs
	Gross	40.5kgs
Packing Information of LCD	Net Weight.(Kgs)	26.8kgs
	Gross Weight.(Kgs)	32kgs
	Packing Dimension	1900*240*620mm
Packing Information of Base	Net Weight.(Kgs)	6.9kgs
	Gross Weight.(Kgs)	8.5kgs
	Packing Dimension	550*540*140mm

Troubleshooting the Digital Sign

Issue	Probable Cause	Solutions
<ul style="list-style-type: none"> ● No picture or sound 	<ul style="list-style-type: none"> ➤ Unit not plugged into wall outlet ➤ Power cord not properly connected to the terminal on the back of the unit. ➤ Unit not powered on ➤ Wall outlet not working 	<ul style="list-style-type: none"> □ Check that the unit is plugged into wall outlet. □ Confirm that the power cord is connected to the terminal on the back of the unit. □ Turn the on/off toggle switch located on the back of the unit, lower center, to the “on” position. □ Unplug unit, wait 20 seconds, plug unit back into outlet and try again. □ Make sure that outlet is working by plugging in a different electrical device. ❖ If all of the above have been checked and the issue is not resolved, contact a customer service representative.
<ul style="list-style-type: none"> ● No sound (but picture is working) 	<ul style="list-style-type: none"> ➤ Volume not adjusted on the remote control. ➤ Content/Video does not have sound. ➤ Content format is not compatible. ➤ Speakers do not work. 	<ul style="list-style-type: none"> □ Adjust volume using the remote control □ Confirm content is one of the following compatible formats: AVI, MPEG4, WMV, MKV, flv, MP3, MP4, MOV. □ If unit is connected to Wi-Fi, go to YouTube and play video that has sound □ Unplug unit, wait 20 seconds, plug unit back into outlet and try again. □ Try playing the content on a different device (smart phone, computer or tablet) ❖ If all of the above have been checked and the issue is not resolved, contact a customer service representative.
<ul style="list-style-type: none"> ● No picture (but sound is working) 	<ul style="list-style-type: none"> ➤ Content file damaged. ➤ Content format is not compatible. ➤ Screen damaged or defective. 	<ul style="list-style-type: none"> □ Confirm content is one of the following compatible formats: AVI, MPEG4, WMV, MKV, flv, MP3, MP4, MOV. □ Try playing the content on a different device (smart phone, computer or tablet) □ Unplug unit, wait 20 seconds, plug unit back into outlet and try again. ❖ If all of the above have been checked and the issue is not resolved, contact a customer service representative.
<ul style="list-style-type: none"> ● Remote control not working 	<ul style="list-style-type: none"> ➤ Batteries not inserted properly. ➤ Batteries are dead. ➤ Standing too close or too far from the unit. 	<ul style="list-style-type: none"> □ Check that battery is inserted properly with positive and negative orientation. □ Insert new batteries. □ Stand within 1 foot of the front of the unit and point the remote directly at the sensor (green dot) ❖ If all of the above have been checked and the issue is not resolved, contact a customer service representative.

<ul style="list-style-type: none"> ● No Wi-Fi signal 	<ul style="list-style-type: none"> ➤ Wi-Fi is not turned on in product settings. ➤ Wi-Fi is not connected to a network ➤ Low or no signal from the router ➤ Antenna is missing or not pointed upward. ➤ Damaged PC board 	<ul style="list-style-type: none"> □ Check that Wi-Fi is turned on in settings <ul style="list-style-type: none"> ○ Click the settings icon from the Android home screen.  ○ Click "Wi-Fi". ○ Click the on/off icon in the upper right hand corner to turn on Wi-Fi.  ○ "On" will appear on the upper left hand side. ○ Then select your Wi-Fi network □ Confirm that the antenna is in place and pointed upward. □ Check that other devices are receiving the signal. <ul style="list-style-type: none"> ○ If other devices are not receiving the Wi-Fi signal, please contact your internet service provider. □ Unplug or reset the router and wait for 20 seconds. Restart the router and check. ❖ If all of the above have been checked and the issue is not resolved, contact a customer service representative.
<ul style="list-style-type: none"> ● Parts missing or Damaged 	<ul style="list-style-type: none"> ➤ Parts missed during manufacturing. (No charge for replacements) ➤ Parts lost or damaged by the customer. (There is charge for replacements) 	<ul style="list-style-type: none"> ❖ Contact a customer service representative.
<ul style="list-style-type: none"> ● Having problems with installing software or getting content to play 	<ul style="list-style-type: none"> ➤ Did you purchase the DisplayIt!Xpress software from Displays2go? ➤ Did the customer purchase or downloaded another 3rd party software onto the product? 	<ul style="list-style-type: none"> □ If you purchased DisplayIt!Xpress software from Displays2go or from Best Wave directly, please contact Best Wave at support@bestwave.com or (480)368-8900 ext. 2 □ If you purchased or downloaded another 3rd party software onto the product, please contact the 3rd party software company's customer support for assistance.
<ul style="list-style-type: none"> ● Cannot upload content 	<ul style="list-style-type: none"> ➤ Content format is not compatible. ➤ Content files are too large. ➤ Port being used is defective ➤ App being used to play content is defective. ➤ Android board is defective. 	<ul style="list-style-type: none"> □ Confirm content is one of the following compatible formats: AVI, MPEG4, WMV, MKV, flv, MP3, MP4, MOV. □ Confirm file size is less than available space. ❖ If all of the above have been checked and the issue is not resolved, contact a customer service representative.

<ul style="list-style-type: none"> ● Issues using pre-installed apps 	<ul style="list-style-type: none"> ➤ Mistake in storing content to NAND Flash (shown on pg. 11) ➤ App is defective ➤ Android board is defective. 	<ul style="list-style-type: none"> □ SlideShow App steps Explorer > Select USB > Select Multi > highlight files > Editor > Select Copy > Home > NAND > MediaFolder > Images> Editor > Paste <ul style="list-style-type: none"> ○ Open SlideShow app and select desired transitions, slide time and looping > Play □ MX Player steps > Follow same steps as SlideShow App > MediaFolder > Video > Editor > Paste. <ul style="list-style-type: none"> ○ Open MX Player and select video to play. ○ Loop video: While the video is playing, click on the video and there should be 3 dots in the top right corner. Click on the 3 dots > play > check desired Loop option □ If all of the above have been checked and the issue is not resolved, contact a customer service representative.
---	---	--

Cleaning and Maintenance

1. Avoid strong vibration or impact on the product.
2. Keep the product dry to avoid possible damage by moisture.
3. Don't place the product under direct sunlight which may shorten the service life of the screen.
4. Clean screen and product by using a glass cleaner.
5. If the product will not be used for a long time, pull out the power cord to prevent the internal short circuit or other potential dangers.

Names and Contents of Toxic and Hazardous Substances or Elements in the Product

Part name	Toxic and hazardous substances or elements					
	Pb	Hg	Cd	Cr ⁶⁺	PBB	PBDE
Display	○	○	○	○	○	○
Shell	○	○	○	○	×	×
Circuit board assembly *		○	○	○	○	○
Wires	○	○	○	○	○	○
Metal parts	○	○	○	○	○	○
Packaging materials*	○	○	○	○	○	○
Remote control		○	○	○	○	○
Speaker		○	○	○	○	○
Accessories*	○	○	○	○	○	○

* : Circuit board assembly includes PCB and the electronic elements thereof;

Packaging materials include packaging box, styrofoam, etc.;

Other accessories include instruction manual.

○ : the content of the toxic and hazardous substances or elements in the part is lower than the limit specified in GB/T 26572-2011 standard.

× : the content of the toxic and hazardous substances or elements in the part is higher than the limit specified in GB/T 26572-2011 standard.

The table shows that the machine contains harmful substances inside. The data is provided by material suppliers and verified by the company according to the material type. Some materials contain harmful substances that can't be replaced in present technology. We are dedicated to improving this.

The EFUP of the product is ten years. The pollution control label is shown on the right. 

The EFUP is valid only when the user operates in the normal conditions specified in the manual herein.

Waste Electrical and Electronic Products Recycling and Disposal Regulations

To protect the earth, if you do not need this product or its service life expires, please abide by your local ***Waste Electrical and Electronic Products Recycling and Disposal Regulations*** or send it to qualified local manufacture for recycling.

This Manual is for reference only and is subject to change without prior notice.

